



## DBL-2420R

数字型智能无刷电机驱动器

使用手册

以匠心质造，驱动民族工业

■ 技术源自德国  
■ 驱动民族工业



版权所有 不得翻印

【使用前请仔细阅读本手册，以免损坏驱动器】

---

**DBL-2420R**

DBL-2420R

- 
- 
- 
- 
- 
- 
- 
- 
- 
- 
- 
- 
- 
- 

U V W



	20	24	32	VDC
	-	-	10	A
		200	-	W
	0	-	30000	RPM
	-	5		V
	-	20	-	mA
	5	10	10	K
	-	18	-	VDC
	-	37	-	VDC

		-10 55
	40	90%RH
		1000m
		0.5G, 10hz 60hz( )
		-10 +70
		IP21
		0.25Kg

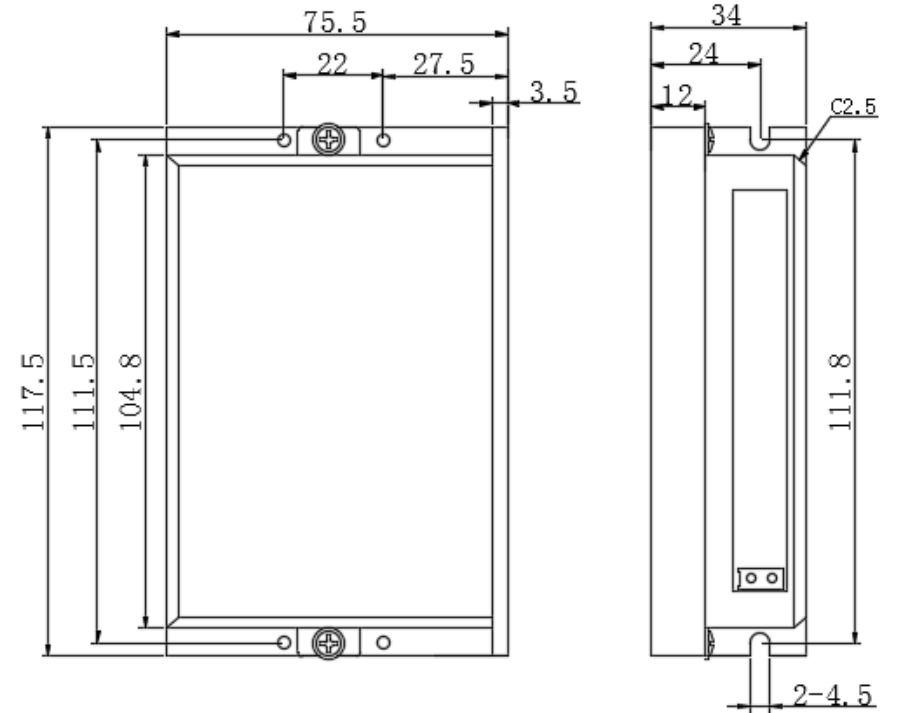

1  
2

60

80

3)

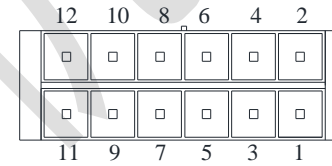
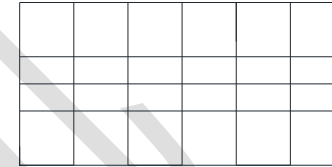
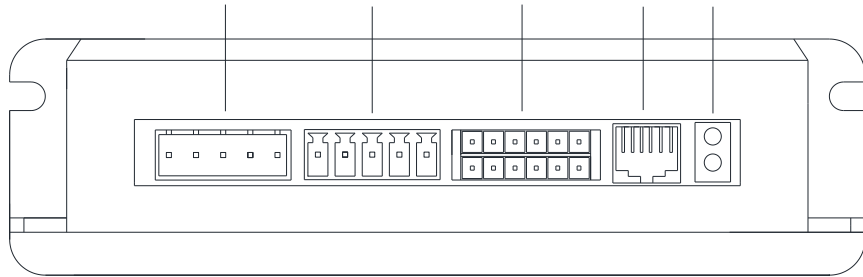

**1 P1 DC**

1	<b>U</b>	U	
2	<b>V</b>	V	
3	<b>W</b>	W	
4	<b>+</b>		<b>+20VDC~+32VDC</b>
5	<b>-</b>		<b>0V</b>

**2 P2**

1	<b>5V</b>		
2	<b>GND</b>		
3	<b>HA</b>	HA	
4	<b>HB</b>	HB	
5	<b>HC</b>	HC	

1	<b>GND</b>		
2	<b>ALM</b>		20mA
3	<b>X1</b>	1	
4	<b>PG</b>		20mA
5	<b>X2</b>	2	
6	<b>5V</b>	5V	20mA
7			

4) RS232

RS232  
RJ12 6PIN

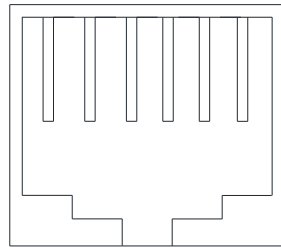

RJ12

1	<b>NC</b>	
2	<b>TXD</b>	MCU
3	<b>VCC</b>	5V
4	<b>RXD</b>	MCU
5	<b>GND</b>	
6	<b>NC</b>	

	LED		
1			
2			
3			
4			
5			
6			
7			

5) LED

1 X1,X2,X3,EN,BK,FR

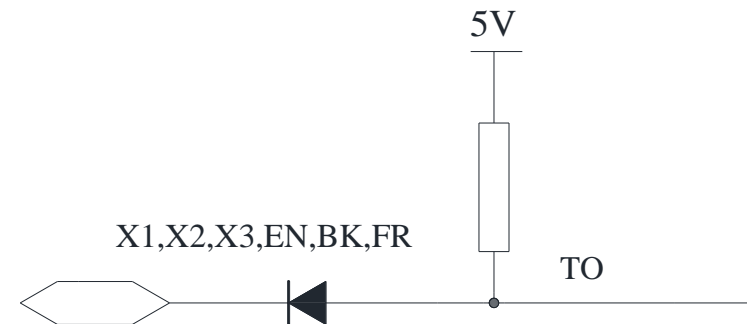

2 PG ALM

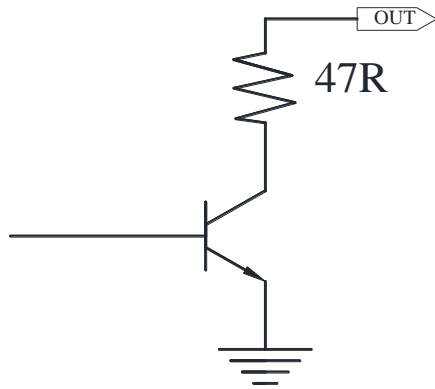

5K-10K

5V LED

2 0-10V

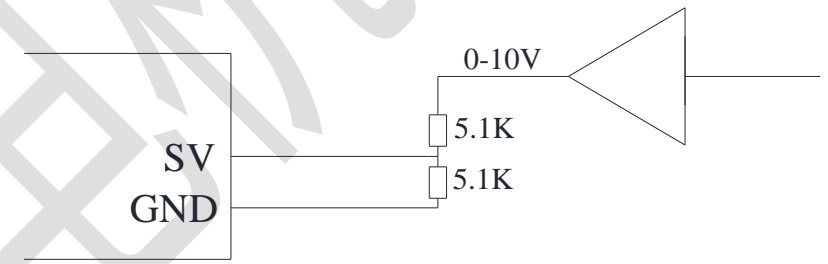

SV /PWM

SV

PWM

BLDC\_2

SV

5V

0-10V

5V

5V

3 SV PWM

1

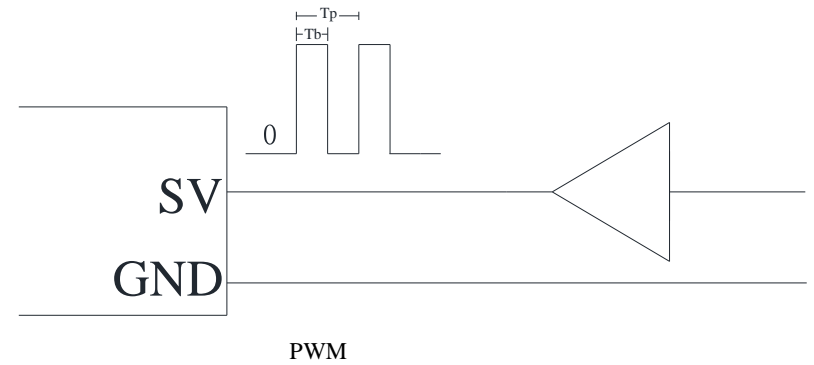
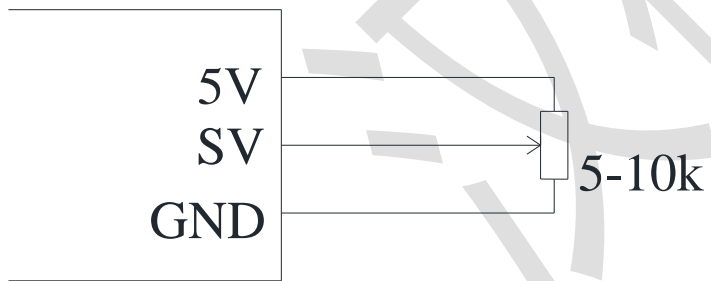

---

PWM SV PWM 5V  
PWM PWM  
0 100% , PWM  
1KHz-20KHz PWM PWM  
2KHz  
**FR**  
FR 0 FR 0

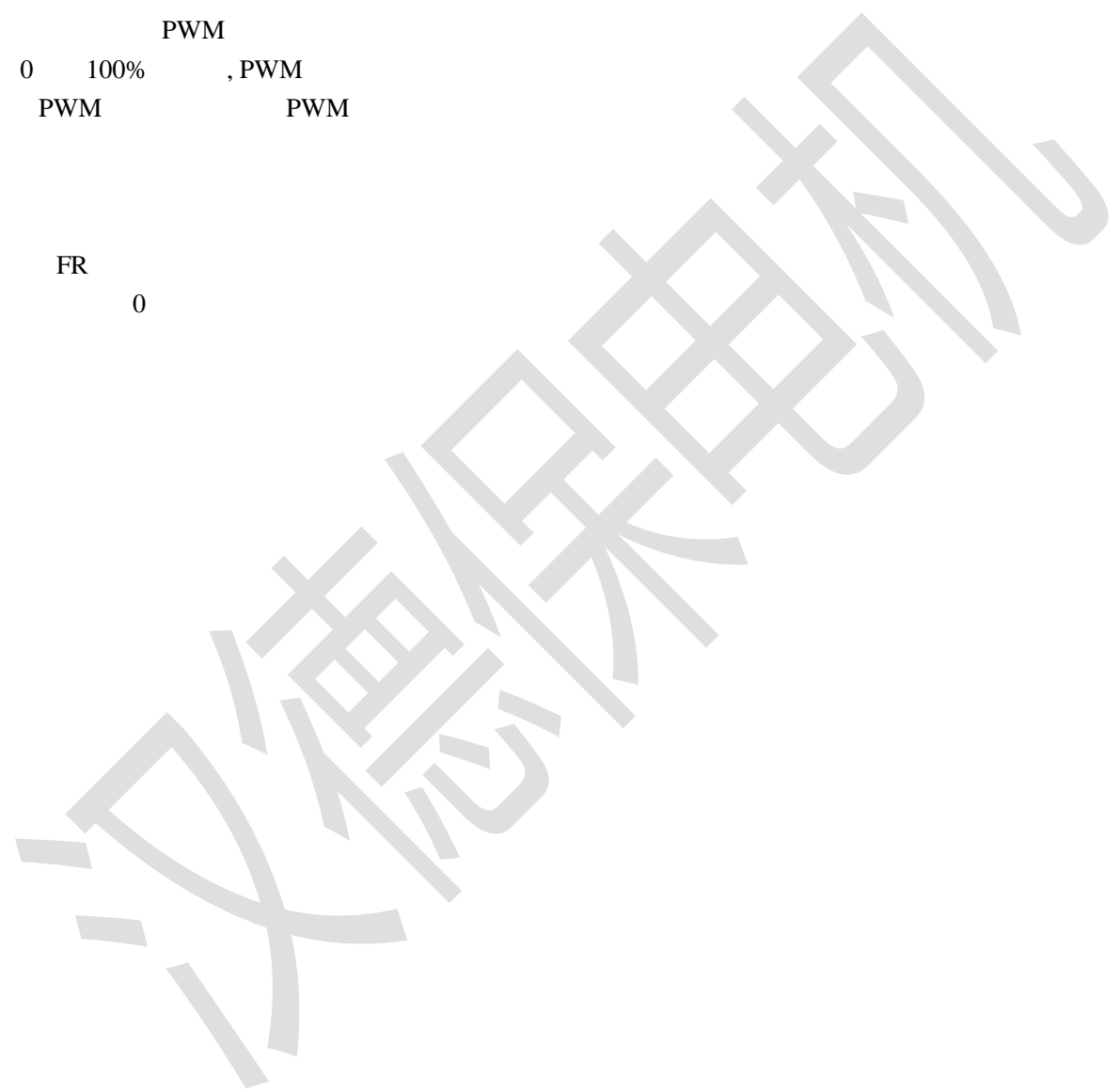



## ALM

ALM

50mA ,

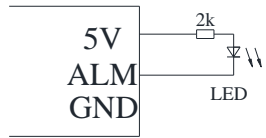

ALM

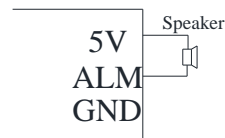
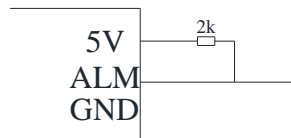

LED

## PG

PG

5V PG

2K-10K  
PG

3  
=  
6

PG

\*

12

PG

RPM =20 × PG

1 2

4 EN

BLDC\_2

300RPM, EN

C B, A

180 240 120

120 240 60 300

B. C. A,

60 300

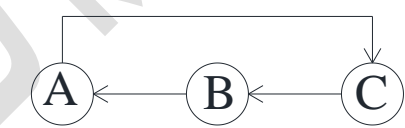

FR

1 EN

60 300, 120 120 180 60 300 300 240 240

A, A B. C,

120 60 300 60 240

240 2 EN

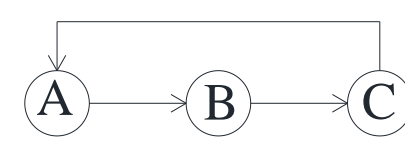

3 EN

60 300 120 120

240 60

6

0 3000 / 1 6000

/ 0 2 PID 0

0 0 0

VP VI

---

**4 质量保证**

[http:// www.hardboy.net](http://www.hardboy.net)

**1 三年保修期**

**2 维修响应时间**

7

7

24

**3 保修限制**